



More Precision

thermoMETER // Non-contact infrared temperature sensors





thermoMETER CS

Compact OEM sensor with integrated controller

- Measuring range from -40°C to 400°C
- Applicable in ambient temperatures up to 80°C without cooling
- Robust, silicon-coated lens
- Integrated controller with LED alarm display and intelligent sighting aid, alarm signal, temperature-code display or self-diagnostics
- Protection against short circuit and polarity change
- Programmable controller
- Different outputs: 0-10V or 0-5V freely scalable, thermocouple type K, alarm output, digital output
- Optional USB interface and software for programming, direct, serial 9.6kBaud interface
- Extensive supply voltage range: 5 - 30VDC
- Best price - ideal for OEM applications
- *Please note: available from 10 pieces*

Optical specifications thermoMETER CS

□ = smallest spot size / focal point (mm)

Standard Focus										
SF15	15:1	6.5	11.6	16.6	21.7	26.7	35	43.3	51.6	9.9
	distance in mm	0	100	200	300	400	500	600	700	800
Close Focus (with optionally available CF lens)										
CF15	15:1	7	3.9	0.8	4.7	8.6	12.5	16.4	20.3	24.2
	distance in mm	0	5	10	15	20	25	30	35	40

Model	CS-SF15-C1	CSTK-SF15-C1
Optical resolution	15:1	
Temperature range ¹	-40°C to 400°C	
Spectral range	8 to 14µm	
System accuracy ²	±1.5% or ±1.5°C	
Repeatability ²	±0.75% or ±0.75°C	
Temperature resolution ³	0.1°C	
Response time	25ms to 999s (90%), adjustable	
Emissivity/Gain	0.100 to 1.100 (adjustable via 0 to 5VDC input or software)	
Transmissivity/gain ¹	0.100 to 1.100	
Signal processing ¹	peak hold, valley hold, average; extended hold function with threshold and hysteresis	
Certificate of calibration	optional	
Outputs/analog	0 to 5V or 0 to 10V 1/10/100 mV/°C	additional thermocouple type K 0 to 5V or 0 to 10V
Alarm output	Alarm 0-30V/50mA (open collector)	
3-state alarm output	adjustable thresholds and voltage levels for: no alarm, pre-alarm, alarm	
Outputs/digital	mono-/bidirectional, 9.6kBaud, 0/3V level/USB optional	
LED functions	alarm display, automatic aiming aid, self-diagnostics, temperature display (via temp. code)	
Inputs	programmable functional inputs for external emissivity adjustment, ambient temperature compensation (0 to 5VDC), hold function or RS232 / USB (optional) communication	
Cable length	1m (standard), 3m, 8 m, 15m	
Power supply	4mA (without LED); 10mA (5 to 30VDC)	
Protection class	IP63 (NEMA-4)	
Ambient temperature	-20°C to 80°C	
Storage temperature	-20°C to 85°C	
Relative humidity	10 to 95%, non-condensing	
Vibration	IEC 68-2-6: 3 G, 11 to 200Hz, any axis	
Shock	IEC 68-2-27: 50 G, 11ms, any axis	
Weight	58g	

¹ adjustable via software

² ambient temperature: 23±5°C; whichever is greater; object temperature ≥ 0°C

³ with object temperature <100°C and time constant of >0.2s

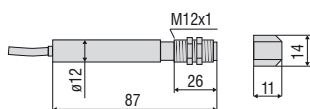

Product identification

CS -	SF15-	C1
Cable length [1m (standard) / 3m / 8m / 15m]		
Focus [SF]		
thermoMETER CS / CSTK		

Accessories page 54 - 55

- Ancillary CF lens
- Protective window
- Mounting bracket / mounting bolt
- Air purge collar
- Right angle mirror

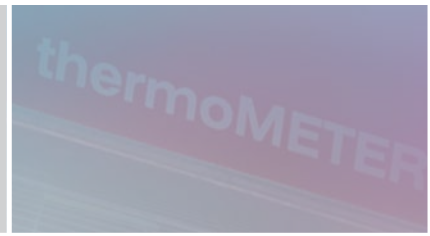

Mechanical accessories CS / CSmicro / CSmicro 2W

Art. No.	Model	Description
2970279	Emissivity	Mounting bracket, fixed
2970280	TM-AB-CS	Mounting bracket, adjustable
2970281	TM-MB-CS	Mounting bolts with M12x1 thread
2970282	TM-MG-CS	Mounting fork, adjustable in 2 axes, with M12x1 fastening
2970283	TM-AP-CS	Air purge collar for 10:1 sensors
2970284	TM-APL-CS	Air purge collar, laminar
2970285	TM-APLCF-CS	Air purge collar, laminar with integrated ancillary CF lens
2970286	TM-RAM-CS	Right angle mirror for measurements 90°C to the sensor axis
2970287	TM-USBK-CS	USB kit: USB programming adapter, CompactConnect software

Optical accessories CS / CSmicro / CSmicro 2W

2970277	TM-CF-CS	Ancillary CF lens for CS models
2970278	Aluminum	Protective window for CS models

Calibration CS / CSmicro / CSmicro 2W

2970288	TM-CERT-CS	Certificate of calibration
---------	------------	----------------------------

Mechanical accessories CX

Art. No.	Model	Description
2970307	TM-AP-CX	Air purge collar, aluminum (anodized)
2970321	TM-FB-CX	Mounting bracket, adjustable in 1 axis, stainless steel
2970322	TM-AB-CX	Mounting bracket, adjustable, in 2 axes, stainless steel
2970311	TM-USBK-CX	USB kit: USB programming adapter, CompactConnect software

Optical accessories CX

2970302	TM-CF-CX	Ancillary CF lens for CX models
2970303	TM-PW-CX	Protective window for CX models

Calibration CX

2970323	TM-CERT-CX	Certificate of calibration
---------	------------	----------------------------

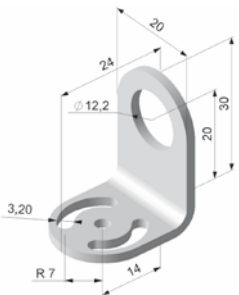

TM-FB-CS mounting bracket, fixed

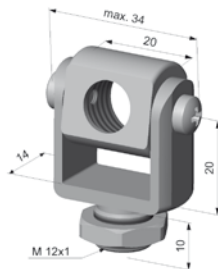

TM-MG-CS Mounting fork with M12x1 thread, adjustable in two axes

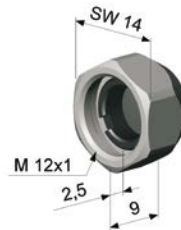

TM-CF-CS Ancillary CF lens (only for LT models)

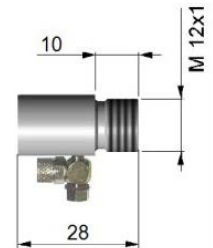

TM-AP-CS Air purge collar for 10:1 sensors

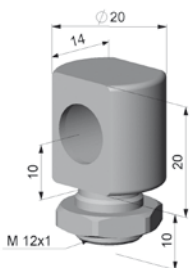

TM-MB-CS Mounting bolts with M12x1 thread adjustable in one axis

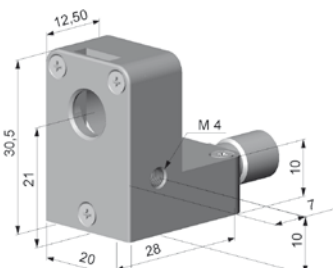

TM-APL-CS Air purge collar, laminar

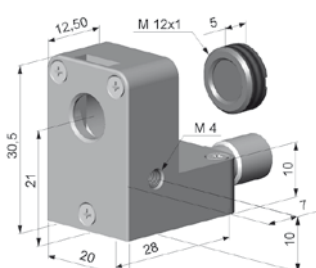

TM-APLCF-CS Air purge collar, laminar with integrated ancillary CF lens



TM-APL-CS Air purge collar, laminar
TM-MG-CS Mounting fork

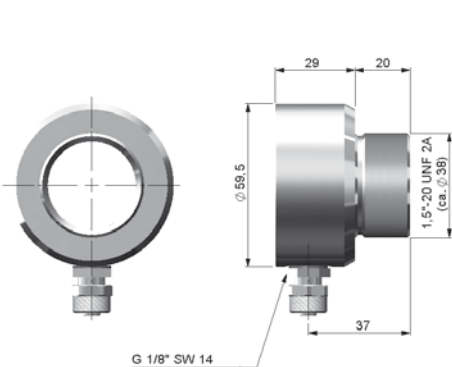

TM-AP-CX Air purge collar for CX sensors

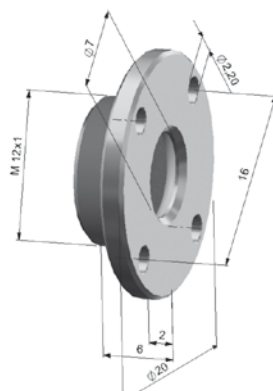

TM-CF-CX Ancillary CF lens, TM-PW-CX Protective window



TM-RAM-CS Right angle mirror

Further IR temperature measurement devices from Micro-Epsilon



thermoIMAGER TIM
Compact USB thermal imaging cameras
for precise thermography



thermoMETER CTVideo/CSVideo
Infrared temperature sensors with crosshair
laser sighting and video output



thermoMETER Handheld
Innovative handheld pyrometer with laser
sighting for inspection and maintenance